

PC10422

ARCNET® Network Interface Modules for PC/104 Bus Computers

INSTALLATION GUIDE

INTRODUCTION

The PC10422 series of ARCNET network interface modules (NIMs) links PC/104 compatible computers with the ARCNET local area network (LAN).

ARCNET is classified as a token-bus LAN operating at 2.5 Mbps while supporting 255 nodes. Interfacing ARCNET to a host computer typically requires a NIM which plugs into the host computer bus.

The PC10422 is designed with the COM20022 ARCNET controller chip with enhanced features over earlier generation ARCNET chips. New features include command chaining, 16-bit capability, sequential access to internal RAM, duplicate node ID detection and variable data rates up to 10 Mbps. Bus contention problems are reduced because the module only requires an I/O address, and there is no requirement for wait-state arbitration. In addition, the +5V only operation reduces system cost by eliminating multiple voltage power sources.

Each PC10422 module has two LEDs on the board for monitoring network operation and bus access to the module. It is equipped with an 8 position, general purpose DIP switch typically used to reassign the ARCNET node address without removing the module. Ultimately, the node address is configured via software so the DIP switch can also indicate user defined functions such as data rate, cable interface, or master/slave status of the PC/104 system.

There are several models of the PC10422 that allow for flexible cabling options. The PC10422-CXS supports coaxial star configurations requiring external active or passive hubs. The PC10422-CXB supports a coaxial bus configuration usually requiring no hubs, allowing multiple modules to communicate over a single coaxial cable. Similarly, the PC10422-TPB supports twisted-pair bus cabling using either RJ-11 or screw terminal connectors.

The PC10422 Series also supports three separate EIA-485 physical layer implementations. The PC10422-485D supports the EIA-485 DC-coupled

cabling standard while the PC10422-485X provides transformer-coupled EIA-485 operation. Certain applications require that the COM20022 be operated in backplane mode. The PC10422-4000 is intended for these applications and supports the transformer-coupled EIA-485 physical layer interface. All EIA-485 models are fitted with dual RJ-11s and a 3-position screw terminal connector to ease field wiring.

SPECIFICATIONS

Temperature Range

Operating temperature: 0°C to +60°C

Storage temperature: -40°C to +85°C

Data Rates

PC10422-CXB, -CXS, TPB 2.5 Mbps only

PC10422-485D 10 Mbps, 5 Mbps, 2.5 Mbps, 1.25 Mbps,
625 kbps, 312.5 kbps, 156.25 kbps

PC10422-4000, -485X 10 Mbps, 5 Mbps, 2.5 Mbps, 1.25 Mbps

Dimensions

3.550" x 3.775"

(90 mm x 95 mm)

Shipping Weight

1 lb. (.45 kg)

I/O Mapping

Supports I/O Mapping on any 16-byte boundary

Interrupt Lines

Supports strapping of IRQ 3, 4, 5, 6, 7, 9, 10, 11, 12, 14, or 15

Compatibility

PC10422 series NIMs are compliant with ANSI/ATA 878.1 and PC/104 Specification 2.3.

Regulatory Compliance

FCC Part 15 Class A

CE Mark

Power Requirements

Model	+5 V
PC10422-4000	200 mA
PC10422-485D	200 mA
PC10422-485X	200 mA
PC10422-CXB	200 mA
PC10422-CXS	200 mA
PC10422-TPB	200 mA

INSTALLATION

Mounting the PC10422

The PC10422 incorporates stack-through connectors and is shipped with four 0.6" standoffs to facilitate mounting of the PC10422 onto the PC/104 stack. The PC10422 should be mounted below the 8-bit modules if any are present in the system. If another eight-bit module is to be mounted above the PC10422, use the enclosed standoffs. On some older eight-bit modules, only two mounting holes are provided so only two standoffs are used. If the PC10422 is the last module on the stack, use either two or four M3x0.5-5MM panhead screws (not provided) to complete the mounting onto the stack. Once mounted, field connections can be made.

Since the PC/104 stack does not make provision for a chassis (earth) connection, a metal screw terminal has been provided for this purpose. Simply connect one end of a green earthing wire to the screw terminal and the other end to a suitable chassis ground. Jumper E9 is provided to connect the metal screw terminal to 0Vdc on the module. Refer to Figure 7.

Register Map

The PC10422 requires 16 contiguous I/O address locations in order to access the COM20022 register and node ID switch. Because several locations are reserved, it is important not to address another device to these locations. The register map is shown in Table 1.

I/O Address	Read Register	Write Register
Base + 0	Status	Interrupt Mark
Base + 1	Diagnostic Status	Command
Base + 2	Address Pointer High	Address Pointer High
Base + 3	Address Pointer Low	Address Pointer Low
Base + 4	Data	Data
Base + 5	Sub Address	Sub Address
Base + 6	Configuration	Configuration
Base + 7	Tent ID/.../Next ID	Tent ID/.../Next ID
Base + 8	Node ID Switch	Reserved
Base + 9	Node ID Switch	Reserved
Base + A	Reserved	Reserved
Base + B	Reserved	Reserved
Base + C	Reserved	Reserved
Base + D	Reserved	Reserved
Base + E	Reserved	Reserved
Base + F	Reserved	Reserved

Table 1—Register Map

I/O Base Addressing

The I/O base address for the register map can be set with jumpers at the E2 (ADDR) jumper location.. The PC10422 does not require any memory address space simplifying installation. See Table 2 and Figure 7 for details.

A9	A8	A7	A6	A5	A4	I/O ADDRESS
■		■	■	■	■	100
■		■	■	■		110
■		■	■		■	120
■		■	■			130
■		■		■	■	140
■		■		■		150
■		■			■	160
■		■				170
■			■	■	■	180
■			■	■		190
■			■		■	1A0
■			■			1B0
■				■	■	1C0
■				■		1D0
■					■	1E0
■						1F0
	■	■	■	■	■	200
	■	■	■	■		210
	■	■	■		■	220
	■	■	■			230
	■	■		■	■	240
	■	■		■		250
	■	■			■	260
	■	■				270
	■		■	■	■	280
	■		■	■		290
	■		■		■	2A0
	■		■			2B0
	■			■	■	2C0
	■			■		2D0

A9	A8	A7	A6	A5	A4	I/O ADDRESS
	■				■	2E0
	■					2F0
		■	■	■	■	300
		■	■	■		310
		■	■		■	320
		■	■			330
		■		■	■	340
		■		■		350
		■			■	360
		■				370
			■	■	■	380
			■	■		390
			■		■	3A0
			■			3B0
				■	■	3C0
				■		3D0
					■	3E0
						3F0

Key: ■ = Install Jumper

Table 2—I/O Base Address

Interrupts

Interrupts can be invoked at jumper location E1 (IRQ) which consists of a series of rows of two posts each. Each row is labeled an interrupt line corresponding to the PC bus interrupt designators. To enable an interrupt, insert a jumper across a pair of posts corresponding to the desired interrupt. Only one interrupt can be selected; therefore, only one jumper is supplied. If no interrupts are desired, remove all jumpers at jumper location E1 (IRQ). Refer to Figure 7 for details.

Indicator Lights

There is a dual LED located near the PC10422 field connectors. The yellow LED indicates that the PC10422 is being accessed via its I/O address. The green LED indicates that the PC10422 is receiving ARCNET traffic from the network.

Warning This is a Class A product as defined in EN55022. In a domestic environment this product may cause radio interference in which case the user may be required to take adequate measures.

Node ID Switch

Although not always necessary with the COM20022, the PC10422 provides a separate input port that reads an 8-bit DIP switch (SW1) located near the board edge. This switch is intended to serve as a node ID switch, although it can serve as a general purpose switch if desired. The node ID switch has no connection to the COM20022 ARCNET controller chip.

The most significant bit (MSB) is switch position 1 (far left), and the least significant bit (LSB) is switch position 8 (far right). A switch in the open position (off position or away from the printed circuit board) introduces a logic "1." Figure 1 shows the node ID switch. In this example, the switch is set to hexadecimal address F5.

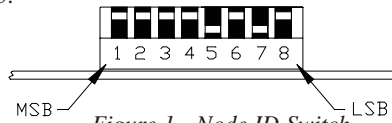

Figure 1—Node ID Switch

FIELD CONNECTIONS

The PC10422 is available in several transceiver options. Each transceiver, which is matched to a particular cable type, is identified by a suffix appended to the model numbers. The capabilities of each transceiver differs.

-CXS Coaxial Star

In a coaxial star system, NIMs and hubs are interconnected in a point-to-point fashion using coaxial cable. A NIM can connect to one other NIM or can connect to an unused port on a hub. Hub-to-hub connections are allowed.

In a two node system, simply connect the two -CXS NIMs together using RG-62/u coaxial cable. The length of cable cannot exceed 2000 feet.

If more than two NIMs are used on a network, either an active or passive hub is required. With passive hubs, a maximum of four NIMs can be interconnected. Unused ports on the passive hub must be terminated with a 93-ohm (nominal) resistor. The maximum length between a passive hub port and a NIM is 100 feet.

Active hubs provide overall better performance than passive hubs since greater distances can be achieved along with a degree of isolation. Connect each NIM to a port on the hub using RG-62/u coaxial cable. This length of cable cannot exceed 2000 feet nor can the length of cable between two cascaded hubs exceed 2000 feet. However, up to ten hubs can be cascaded thereby providing an overall cable length of 22,000 feet. Unused ports on active hubs need not be terminated.

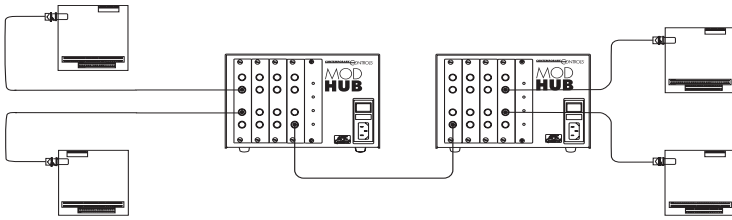

Figure 2—Active hubs can be cascaded for greater distances.

-CXB Coaxial Bus

For hubless systems, the -CXB transceiver can be used. NIMs are interconnected with RG-62/u cables and BNC Tee connectors. Each -CXB NIM represents a high impedance connection in both the powered and unpowered states. Therefore, passive termination must be applied to both ends of a bus segment. Use BNC style 93 (nominal) ohm resistors at each end. The maximum segment length is 1000 feet and the maximum number of NIMs that can be connected to a segment is eight.

To extend a bus segment beyond 1000 feet, an active hub is required. If the hub port is of the -CXS type, connection can be made if a few simple rules are followed. Only connect this bus segment at the end of a segment. Do not connect the hub to the middle of a segment since the hub port is not of the high impedance type. Do not terminate the end which attaches to the hub port since a -CXS port effectively terminates the end of a bus segment. Simply remove the BNC Tee connector and terminator from the segment end and attach the cable directly to the hub port. The opposite segment end still requires termination if no hub connection is being made.

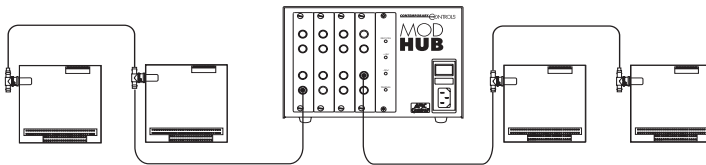

Figure 3—Bus segments can be extended through active hubs.

-TPB Twisted-Pair Bus

The -CXB transceiver can be modified to drive a balanced cable system with the addition of some parts. This configuration is called -TPB and it supports shielded or unshielded twisted-pair cable such as category 5. Dual RJ-11 connectors replace the single BNC connector in order to support the popular modular plug connectors. For convenience, a three-position screw

terminal connector is also provided (see Figure 7). Follow the connector pin assignments in Tables 3 and 4 when using this connector or when mixing cable types. Wiring between NIMs is accomplished in a daisy-chain fashion with point-to-point cables connecting the various NIMs to create a bus segment. The end NIMs will have one vacant RJ-11 socket which is to hold the RJ-11 style 100 ohm terminator required to terminate the end points of the bus segment. When terminating the screw terminal connector, install a 100 ohm, 1/4 watt resistor across terminals 1 and 2. Use twisted-pair cable and observe polarity. Modular plugs must be installed on this cable such that they do not invert the signals. Most satin cable does not twist the pairs nor maintain signal polarity. Do not use this cable. To test for the proper cable connections, hold both ends of the cable side by side with the retaining clips facing the same direction. The color of the wire in the right-most position of each plug must be the same if there is no inversion of the cable. If this is not the case, the cable is inverted. Up to eight -TPB NIMs can be connected to one segment which cannot exceed 400 feet in length.

The overall distance of a twisted-pair network can be expanded beyond 400 feet if hubs are used. Use a hub port that supports the same -TPB interface.

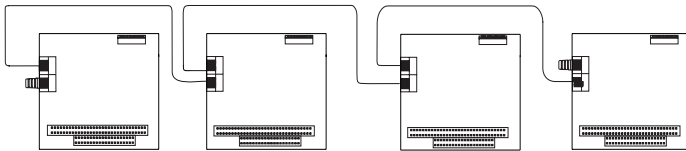

Figure 4—TPB NIMs are connected in a daisy-chain fashion with terminators inserted at both end NIMs.

-485D DC Coupled EIA-485 (Non-Backplane Mode)

The PC10422-485D supports DC coupled EIA-485 communication via a daughter board which replaces the coaxial hybrid transceiver. This daughter board receives the conventional P1 and P2 pulses intended for the coaxial hybrid transceiver and converts them to an elongated P1 pulse (the width is equal to P1 and P2) suitable for the EIA-485 differential driver. Therefore, do not set the COM20022 to backplane mode for EIA-485 communication as recommended in SMSC's application note and data sheet since Contemporary Controls (CC) implements the same signaling on this daughter board. With our approach, the same software driver used for coaxial networks will function with the EIA-485 version of the PC10422 without modification.

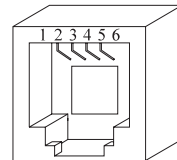

Figure 5—Modular Jack Numbering Orientation

One three-position screw terminal (see figure 7) and two RJ-11 connectors are supplied on each NIM which are bussed together so as to provide a convenient daisy-chain connection for connecting multiple nodes onto one segment. This segment can be up to 900 feet long of category 5 unshielded twisted-pair cable, and as many as 17 nodes can occupy the segment. Make sure that the phase integrity of the wiring remains intact. Pin 3 of the modular jack on each NIM must be connected together.

The same applies to pin 4. Most modular (satin cable) telephone wiring flips the phase of the wiring thereby reversing the connections to pins 3 and 4 at each end. Do not use this type of cable. Some modular cable is not even twisted. Be sure to use the proper cable. Refer to Tables 3 and 4 for connector pin assignments.

Modular Connector Pin Assignments	
6-Contacts	
Pin	Usage
1	Not Available
2	Not Used
3	Line-
4	Line+
5	Not Used
6	Not Available

Table 3—Modular Connector Pin Assignments for -TPB

Termination

Each end of the segment must be terminated in the characteristic impedance of the cable. A 120-ohm resistor can be invoked with a jumper which resides on the EIA-485 daughter board. With the middle jumper inserted at location E1 on the daughter board, 120 ohms of resistance is applied across the twisted-pair. With the jumper removed, no termination is applied. If it is desired to apply external termination instead, remove this jumper and insert an RJ-11 style terminator in the unused RJ-11 modular jack or install a 120 ohm, 1/4 watt resistor across pins 1 and 2 on the screw terminal connector. Incorporating a resistance value less than 120 ohms is not recommended since it may excessively load the EIA-485 transceivers.

PIN	TRANSCIVER			
	-4000	-485D	-485X	-TPB
1	LINE	LINE+	LINE	LINE+
2	LINE	LINE-	LINE	LINE-
3	SHIELD	SHIELD	SHIELD	SHIELD

Table 4—Screw Terminal Connector Pin Assignments for -4000, -485D, -485X and -TPB

Bias

In addition to the termination, it is also necessary to apply bias to the twisted-pair network so that when the line is floated differential receivers will not assume an invalid logic state. There are two precision bias resistors (Rb) of equal value on each daughter board. One resistor is tied to the +5V line while the other is tied to ground. Each resistor has a jumper associated

with it. If the two jumpers are installed, the resistor tied to +5V is connected to the (+) signal line while the grounded resistor is connected to the (-) line. This voltage drop will bias the differential receivers into the “1” state when no differential drivers are enabled. Differential receivers typically switch at or near zero volts differential and are guaranteed to switch at ± 200 mv. Through the transition point, 70 mv of hysteresis will be experienced. Therefore, a positive bias of 200 mv or greater will ensure a defined state. We recommend that bias be applied to both ends of the wiring segment by installing the two end jumpers located at position E1 on the daughter board. This is to be done for only the two NIMs located at the end of the segment. All other NIMs will have their jumpers removed.

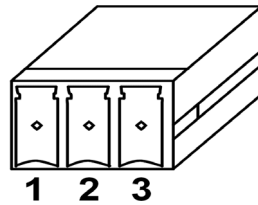

*Figure 6—Screw
Terminal Connector
Numbering Orientation*

The termination and bias rules are simple. If the NIM is located at the extreme ends of the segment, install all three jumpers at location E1 on the daughterboard. If the NIM is located between the two end NIMs, remove all three jumpers. If external termination is desired, remove the middle jumper at E1.

For EIA-485 DC operation, it is very important that all devices on the wiring segment be referenced to the same ground potential in order that the common mode voltage requirement (± 7 Vdc) of the EIA-485 specification is achieved. This can be accomplished by running a separate ground wire between all PC computers or by relying upon the third wire ground of the power connector assuming that the DC power return is connected to chassis ground on the PC computer. Another approach would be to connect the DC common of each PC computer to a cold water pipe. Connected systems, each with different elevated grounds, can cause unreliable communications or damage to the EIA-485 differential drivers. Therefore, it is important that an adequate grounding method be implemented. A ground (chassis) connection can be found at pin 3 of the screw terminal connector.

Segments of -485D connected NIMs can be extended through the use of active hubs. Select a MOD HUB expansion module with a -485D compatible port. Connect one end of the segment to this port following the same termination rules as used for a NIM. This hub port counts as one NIM when cable loading is being calculated. The NIM electrically closest to the hub port should not have any termination or bias applied. Follow the same rules for other segments attached to different hub ports. Each hub effectively extends the segment another 900 feet. Maintain the same cabling polarity as the NIMs by using cable connections that do not invert the signals.

-485X AC Coupled EIA-485

The AC coupled EIA-485 transceiver offers advantages over DC coupled EIA-485. No bias adjustments need to be made since each transceiver has its own fixed bias network isolated by a pulse transformer. Unlike the DC coupled EIA-485, wiring polarity is unimportant. Either inverted or straight through cable can be used or even mixed within one AC coupled network. Much higher common mode voltage levels can be achieved with AC coupling due to the transformer coupling which has a 1000 Vdc breakdown rating.

There are disadvantages to the AC coupled transceiver as compared to the DC coupled technology. The DC coupled distances are longer (900 feet) compared to the AC coupled distance (700 feet). The AC coupled transceiver will operate at 1.25, 2.5, 5.0 and 10.0 Mbps while the DC coupled transceiver will operate over all seven data rates.

The cabling rules of the -485X are similar to the -485D. Dual RJ-11 connectors and one three-position screw terminal connector are used in each NIM. Wire a maximum of 13 NIMs in a daisy-chain fashion leaving the end NIMs with vacant RJ-11 connections. On these NIMs insert a jumper at E1 on both -485X daughter boards to invoke 120-ohm termination resistors or leave the jumpers open and insert RJ-11 style passive terminators in each of the two vacant RJ-11 jacks. Termination can also be accomplished by installing a 120 ohm, ¼ watt resistor across pins 1 and 2 of the screw terminals at each end of the bus segment. Refer to Tables 3 and 4 for connector pin assignments. Termination should not be applied to any of the NIMs located between the two end NIMs of the segment. Do not mix -485D and -485X NIMs together on one segment; however, bridging of the technologies is possible using active hubs with the appropriate transceivers. To extend -485X segments, use a hub as discussed under the -485D section. Make sure that the active hub transceivers are of the -485X type. Cable inversion is not of any consequence.

-4000 AC Coupled EIA-485 (backplane mode)

The -4000 transceiver is used when backplane mode operation is desired. It is similar to the -485X transceiver in operation but has some subtle differences. A maximum of 8 NIMs may be connected on a single bus segment with up to 262 feet of twisted-pair cable. Termination can be accomplished by installing an RJ-11 style passive terminator in an unused RJ-11 jack or with a 120 ohm, ¼ watt resistor across pins 1 and 2 of the screw terminal connector.

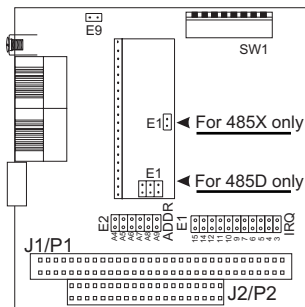

Figure 7—Jumper settings for PC10422 models.

NEED MORE HELP INSTALLING THIS PRODUCT?

More information is on our web site at www.ccontrols.com. This includes technical manuals, software drivers and utility programs that can test the product. When contacting one of our offices, just ask for Technical Support.

Warranty

Contemporary Controls (CC) warrants its new product to the original purchaser for two years from the product shipping date. Product returned to CC for repair is warranted for one year from the date that the repaired product is shipped back to the purchaser or for the remainder of the original warranty period, whichever is longer.

If a CC product fails to operate in compliance with its specification during the warranty period, CC will, at its option, repair or replace the product at no charge. The customer is, however, responsible for shipping the product; CC assumes no responsibility for the product until it is received.

CC's limited warranty covers products only as delivered and does not cover repair of products that have been damaged by abuse, accident, disaster, misuse, or incorrect installation. User modification may void the warranty if the product is damaged by the modification, in which case this warranty does not cover repair or replacement.

This warranty in no way warrants suitability of the product for any specific application. **IN NO EVENT WILL CC BE LIABLE FOR ANY DAMAGES INCLUDING LOST PROFITS, LOST SAVINGS, OR OTHER INCIDENTAL OR CONSEQUENTIAL DAMAGES ARISING OUT OF THE USE OR INABILITY TO USE THE PRODUCT EVEN IF CC HAS BEEN ADVISED OF THE POSSIBILITY OF SUCH DAMAGES, OR FOR ANY CLAIM BY ANY PARTY OTHER THAN THE PURCHASER.**

THE ABOVE WARRANTY IS IN LIEU OF ANY AND ALL OTHER WARRANTIES, EXPRESSED OR IMPLIED OR STATUTORY, INCLUDING THE WARRANTIES OF MERCHANTABILITY, FITNESS FOR PARTICULAR PURPOSE OR USE, TITLE AND NONINFRINGEMENT.

Returning Products for Repair

Return the product to the location from which it was purchased by following the instructions at the URL below:

www.ccontrols.com/rma.htm

DECLARATION OF CONFORMITY

Additional compliance documentation can be found on our website.